

# INSTRUCTION MANUAL FOR SHUFFLEBOARD

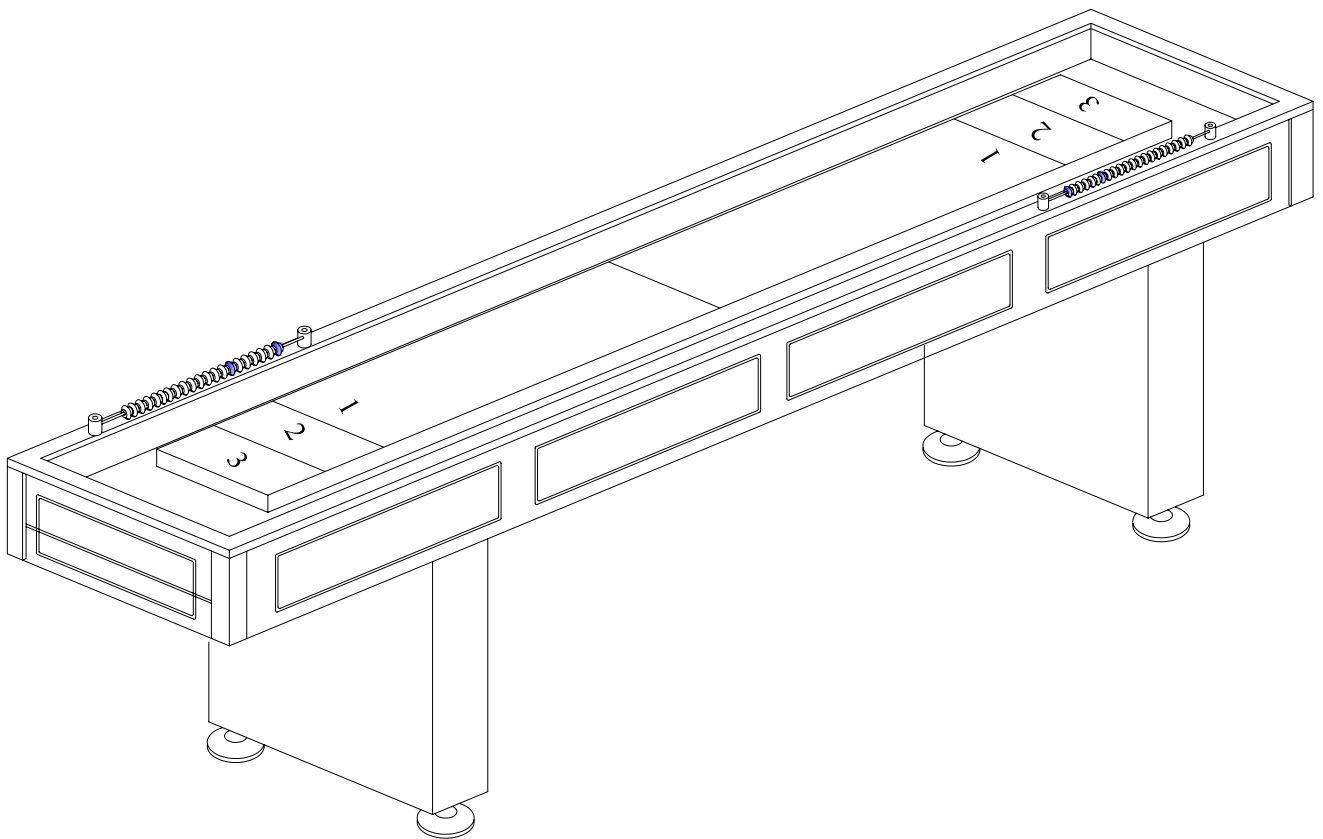

# ASSEMBLY INSTRUCTION

#1

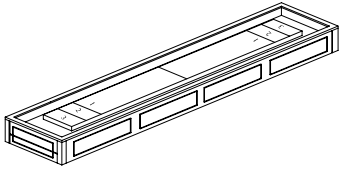

Cabinet  
1 pc

#2

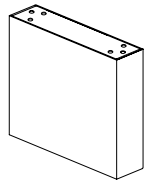

Leg  
2 pcs

#3

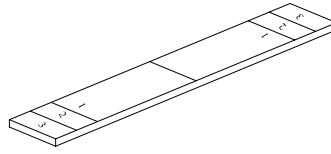

Board  
1 pc

#4

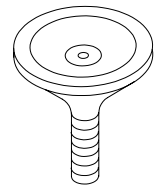

Leg Leveler  
4 pcs

#5

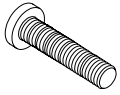

5/16" \* 3/4" Bolt  
24 pcs

#6



5/16" \* 23mm Washer  
24 pcs

#7

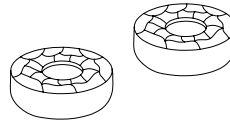

Red and blue puck  
each 8 pcs

#8

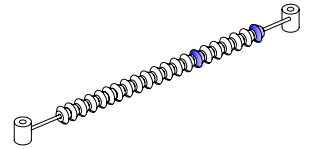

Slide scoring unit  
2 set

#9

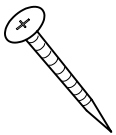

Screw F4 \* 1-1/2"  
4 pcs

#10



Wood cap  
4 pcs

#11



Allen wrench  
1 pc

#12

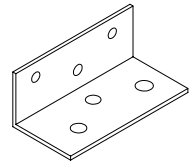

Angle bracket  
4 pcs

#13

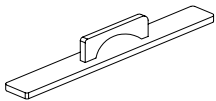

Wiper  
1 pc

#14



Shuffleboard speed wax  
1 pc

#15

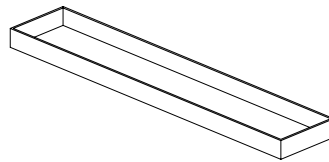

Shuffleboard cover  
1 pc

# ASSEMBLY INSTRUCTION

## Step 1: Assembly of Legs

\* Use blot(#5) and washer(#6) and angle bracket (#12) to secure leg(#2) to cabinet(#1) as shown in the figure 1.

\* Install leg levelers(#4) as shown in the figure 1.

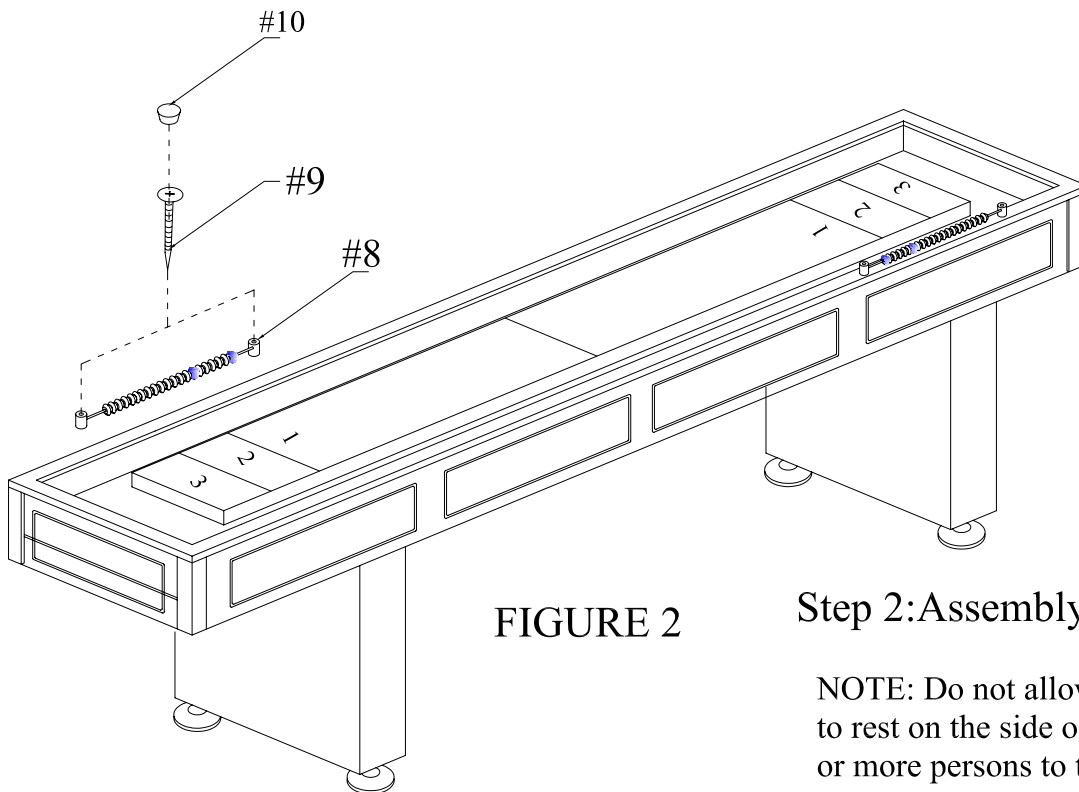
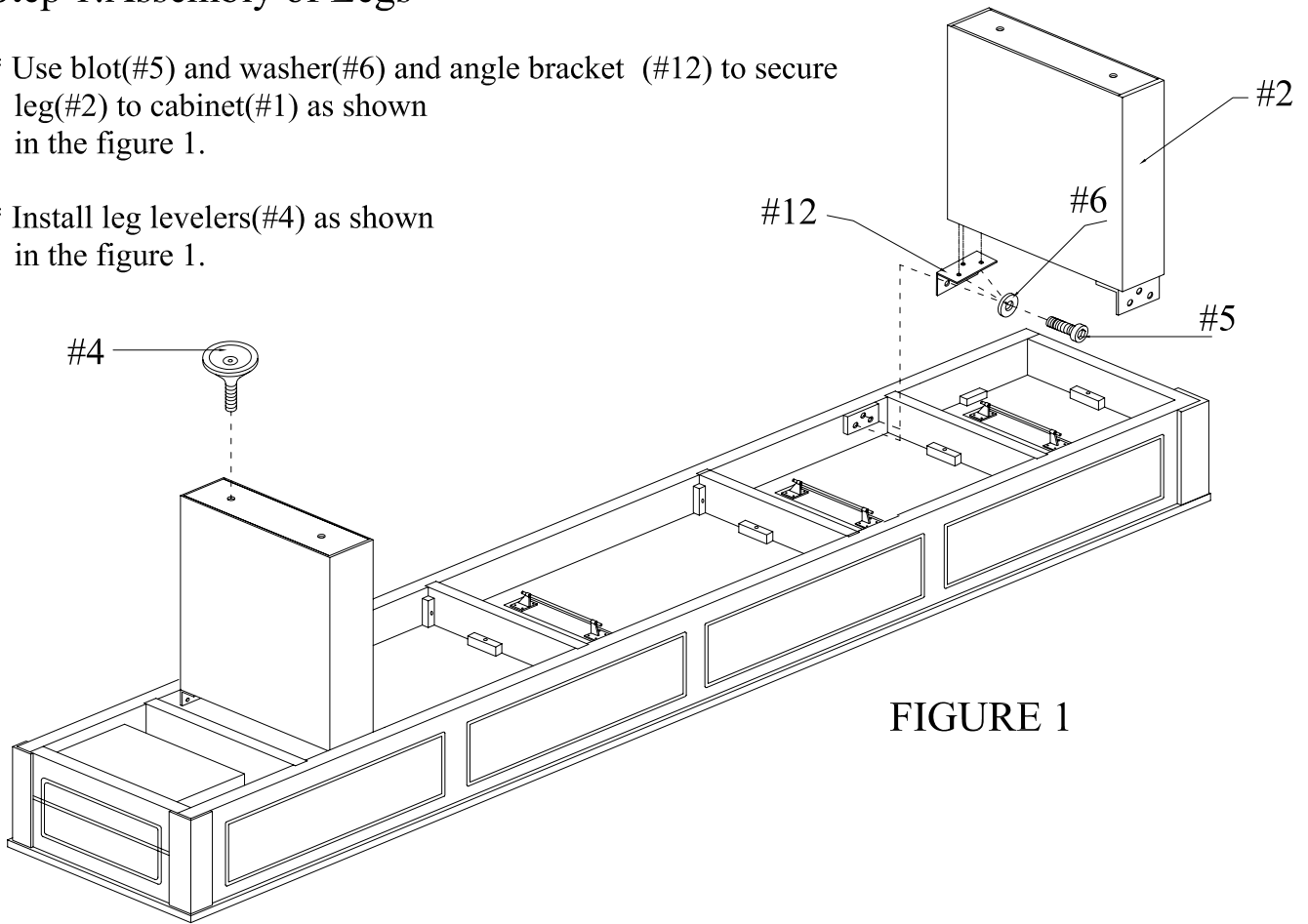

## Step 2: Assembly of slide scorer

NOTE: Do not allow the weight of the table to rest on the side of the legs. Use two person or more persons to turn the table right side up.

\* Use screw(#9) to attach the wood scorer(#8) to the cabinet as shown.

\* Put the wood cap(#10) into screw holes.